

- O( %
- \$ , °:
- ' \$ ' M
- J < CM
- @ - .
- ) ) ' M ĩc ( ' ' %
- ) ) ' M ĩc ) , °C
- ( ' % @ k \$ ( ' % @ k = 0 - ' l j



<L: \$ . , J ' . ' ; M Ž ĩ M Ž . , N

O' \$ \* ' , M ĩc

	(1)			(2)			
					120Vac	220Vac	
700 mA	90~305 Vac	54~108Vdc	75 W	91%	0.99	0.96	EUC-075S070DVY(SVY) <sup>(3)</sup>

- 1 ( ' ' \$ ) + ' M ĩc
- 2 ) ) ' M ĩc ( ' ' %
- 3 J < CM

	90 Vac	-	305 Vac	
	47 Hz	-	63 Hz	
	-	-	0.70 mA	@: - ' , O / \$ ( 2 ) + ' M ĩc & - ' ? z
	-	-	0.9 A	( ' ' % ( ' ' M ĩc
	-	-	0.42 A	( ' ' % ) ) ' M ĩc
@k	-	-	1.70 A <sup>2</sup> s	) ) ' M ĩc ) , °C ( ' % @ k \$ ( ' % @ k = 0 - ' l j

	0.9	-	-	( ' ' \$ ) . . Mác#, ' \$ ' ? z#- , %\$( ' ' %
	-	-	20%	Ž+O\$, N ž

	-5%lo	-	5%lo	( ' ' %
(pk-pk)	-	5%lo	10%lo	( ' ' %
	-	-	10%lo	( ' ' %
	-	-	120 V	
	-	-	± 0.5%	( ' ' %
	-	-	± 1.5%	
	-	2 s	3 s	( ) ' Mác & ) ' Mác#- , %\$( ' ' %
	-	30 s	40 s	( ) ' Mác & ) ' Mác#- , %\$( ' ' % \$*, °: - \$( ' °:
	-	120 s	150 s	( ) ' Mác & ) ' Mác#- , %\$( ' ' % \$, °: - \$*, °:
	-	0.03%/°C	-	= ' °C ~ Kc
( ) M	10.8 V	12 V	13.2 V	
( ) M	0 mA	-	20 mA	" ; im - "

), °:

	-55°C	-	+90 °C	
	-55°C	-	+70 °C	,
	-55°C	-	+85°C	1, % I ? kf ( ' ' % I ?
$\check{C} \times N \times ? \check{z}$ $\check{C} \times N \times ? \check{z}$	$- \% ) \times ) \% - \times ( \% +$ $( , / \times - . \% \times * - \%$			$. \% 0 \times ) \% - \times ( \% +$ $( / , \times - . \% \times * - \%$
	-	780 g	-	

), °:

' - ( ' M	-20 V	-	20 V	
' - ( ' M	200 µA	300 µA	450 µA	Vdim(+) = 0 V
	10%lo	-	100%lo	
	0 V	-	10 V	

), °:

CE	EN 61347-1, EN61347-2-13
CB	IEC 61347-1, IEC 61347-2-13
KS	KS C 7655
<b>EMI</b>	
EN 55015 <sup>(1)</sup>	Conducted emission Test & Radiated emission Test
EN 61000-3-2	Harmonic current emissions
EN 61000-3-3	Voltage fluctuations & flicker
<b>EMS</b>	
EN 61000-4-2	Electrostatic Discharge (ESD): 8 kV air discharge, 4 kV contact discharge
EN 61000-4-3	Radio-Frequency Electromagnetic Field Susceptibility Test-RS
EN 61000-4-4	Electrical Fast Transient / Burst-EFT

EMS	
EN 61000-4-5	Surge Immunity Test: AC Power Line: Differential Mode 4 kV, Common Mode 6 kV
EN 61000-4-6	Conducted Radio Frequency Disturbances Test-CS
EN 61000-4-8	Power Frequency Magnetic Field Test
EN 61000-4-11	Voltage Dips
EN 61547	Electromagnetic Immunity Requirements Applies To Lighting Equipment

ž ž <D @

ž ž <D @

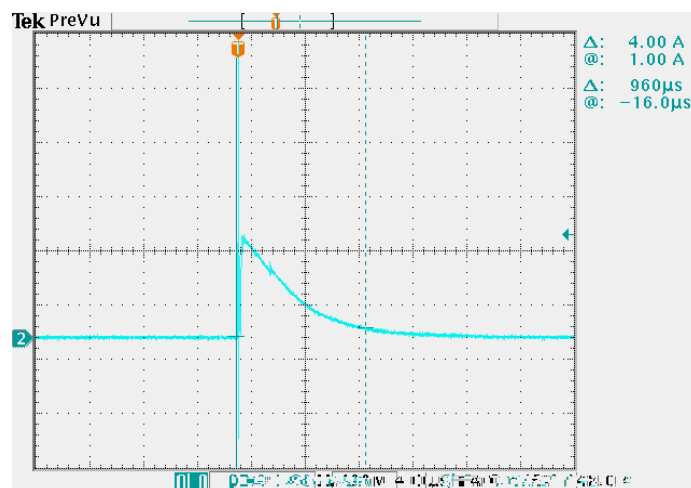

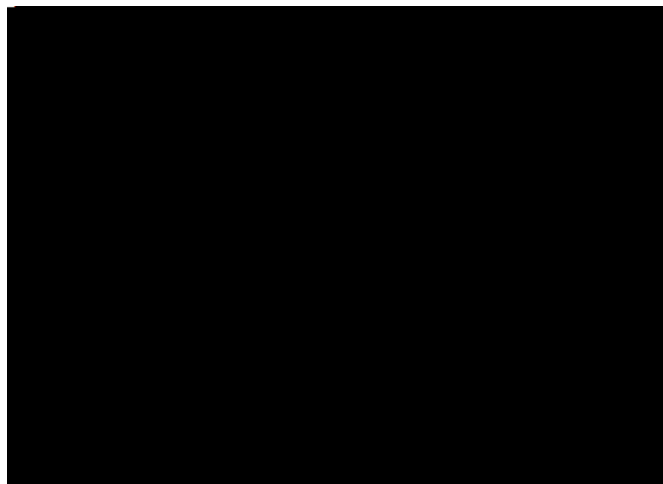
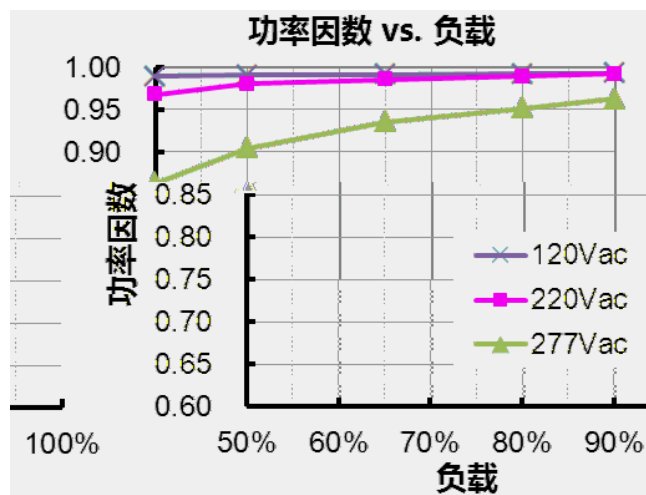
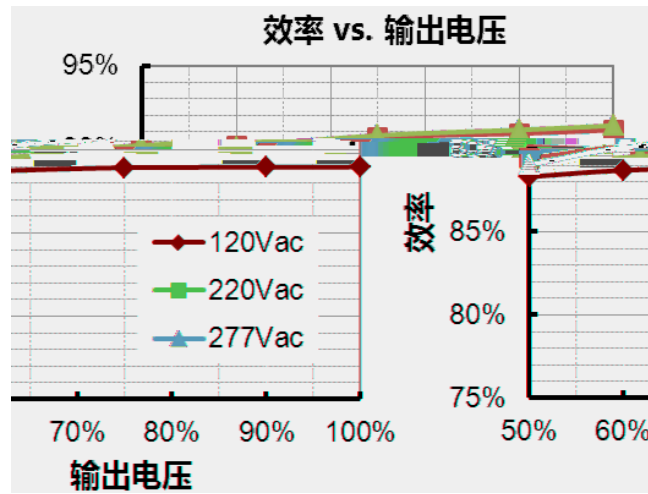

( )' Mac )' Mac

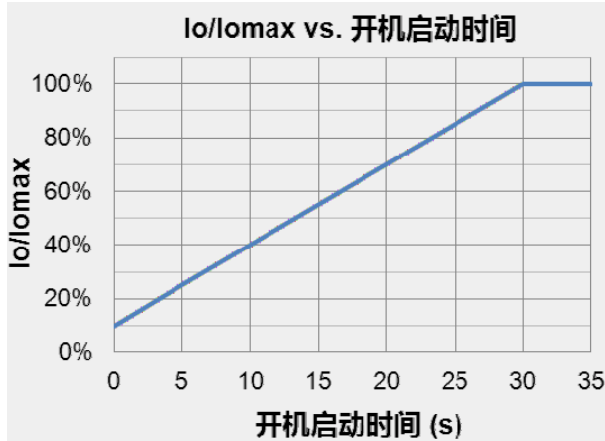

1: Ta (-35°C~-10°C)

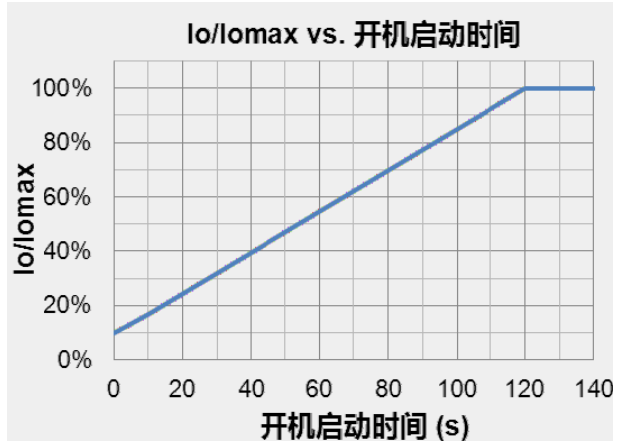

2: Ta (-55°C~-35°C)

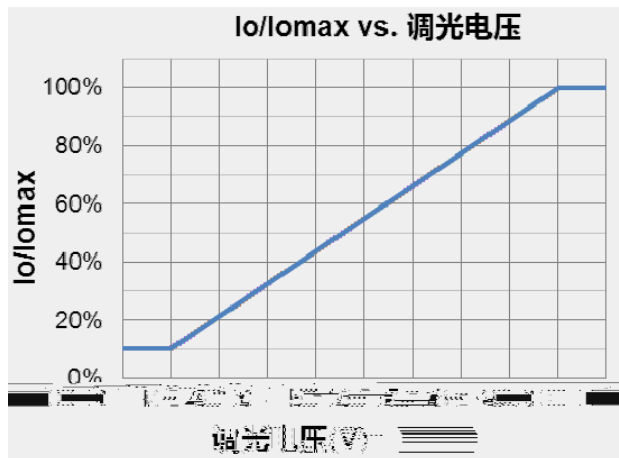
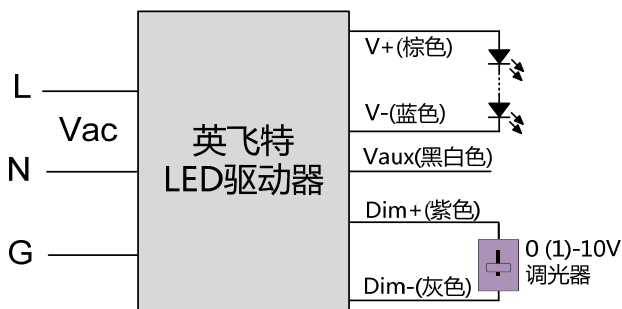

0-10V

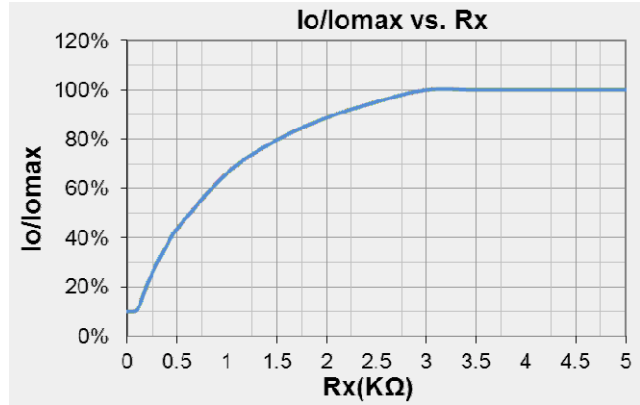
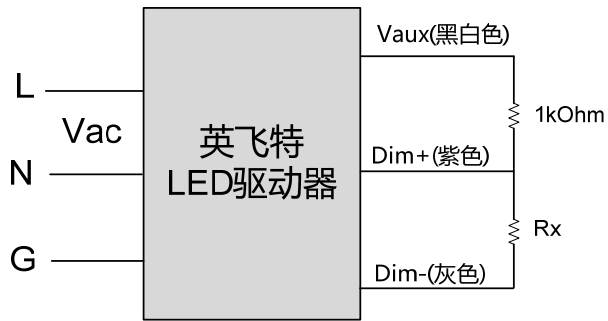

1 DC

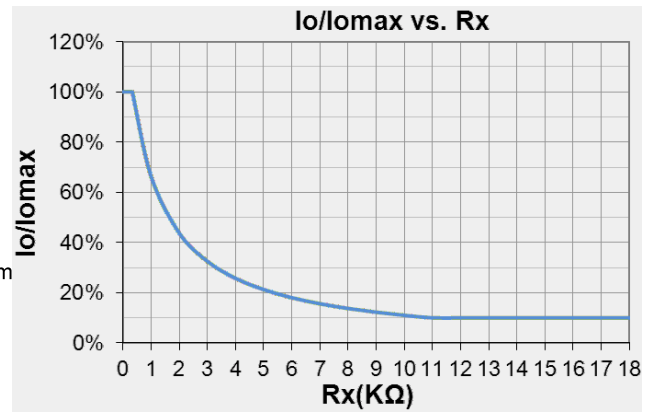
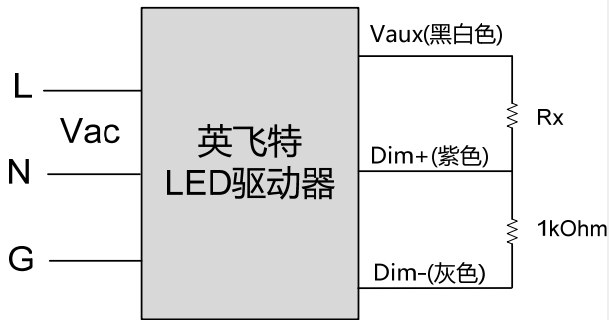

2



3

(%        ' \$( ' M  
 )%        ; im\$        M\$    M  
 \*%        ; im"        M&l x

EUC-075S070DVY

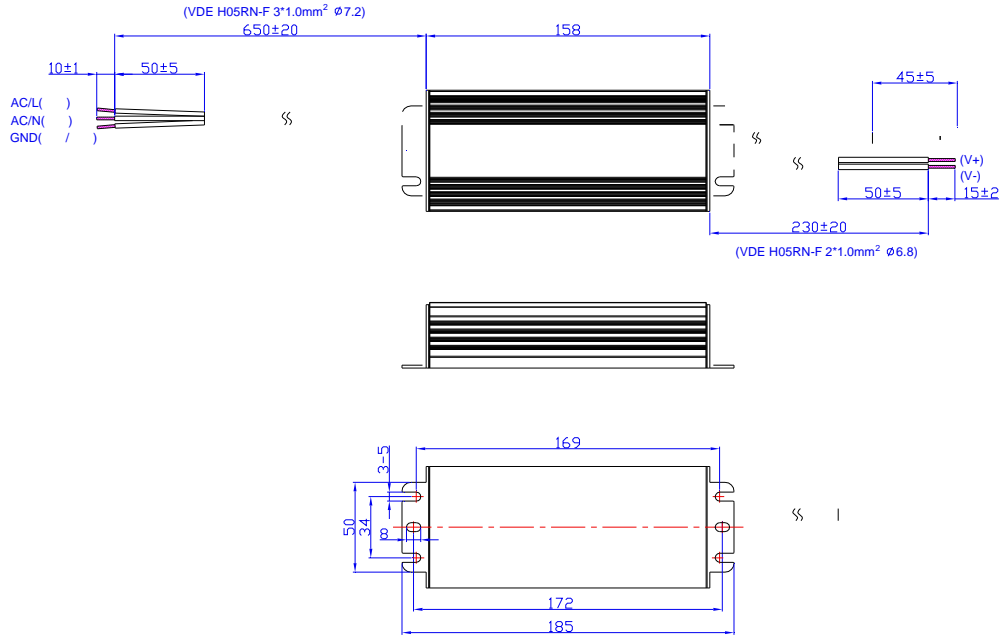



2014-12-18	A		&	&
2019-09-19	B	TUV	&	
		KS	&	
			,	
		&	, ' \$ ' ? z	
			&	
			' ~ ( ' M	
			CB	
			KS	
			EN 61000-4-4	
			EN 61000-4-5	
	&			
	&			
	RoHS	&		